

**Indice capitolo 6 "Tracciatura, truschini e granito"**

*Inhaltsverzeichnis Kapitel 6 "Anreisszeuge, Höhenreisser und Artikel in Granit"*

*Contents chapter 6 "Marking and height gauges, articles in granite"*

Piani in granito

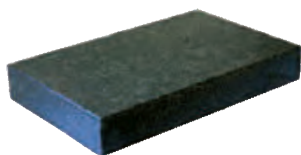

6/3

Supporti per piani



6/3

Squadre in granito



6/4

Righe ad I in granito

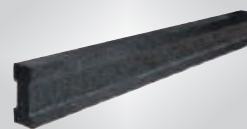

6/4

Art. granito a richiesta



6/5

Art. granito a richiesta



6/5

Art. granito a richiesta

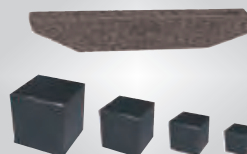

6/5

Blu di Prussia



6/6

Detergenti e cere



6/6

Tracciatori macchina



6/6

Calibri a tracciare



6/7

Tracciatori asta tonda

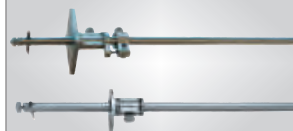

6/7

Compassi semplici



6/8

Compassi a molla



6/9

Truschini meccanici



6/10

Truschini meccanici



6/10

Truschini 2 colonne



6/11

Truschini 2 colonne



6/11

Truschini digitali



6/12

Truschini digitali



6/12

Truschini digitali

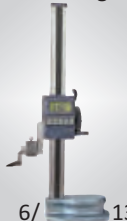

6/13

Accessori truschini



6/13

Calibri per mattonelle



6/14

Punte a tracciare



6/14

## Piani in granito grado DIN 876/00

*Granitplatten Klasse DIN 876/00*

*Granite plates grade DIN 876/00*

- Graniti d'importazione
- Superficie e bordi rettificati e lappati
- Numeri di matricola incisa
- Forniti con certificato di collaudo

- Importierte Granitplatten
- Messfl. und Seiten geschliffen/geläpft
- Gravierte Seriennummer
- Lieferung mit Prüf-Zertifikat

- Imported granite plates
- Surface and edges ground/lapped
- Engraved serial number
- Delivered with test certificate

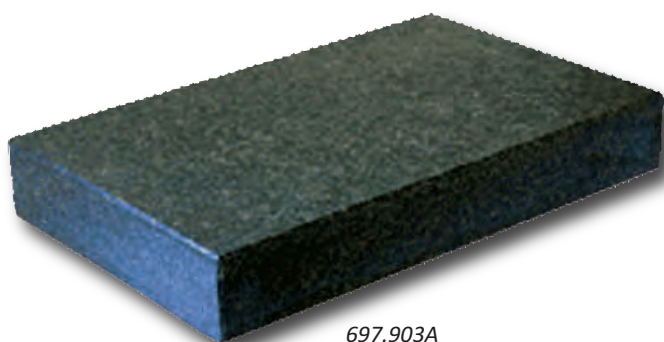

697.903A

| Codice N°<br>Bestell Nr.<br>Order Code | Dimensioni mm<br>Größen mm<br>Dimensions mm | Peso Kg<br>Gewicht<br>Weight | Tolleranza<br>Toleranz<br>Tolerance. |
|--|---|------------------------------|--------------------------------------|
| 697.900A                               | 300 x 200 x 50                              | 9                            | 1,3 µm                               |
| 697.901A                               | 400 x 250 x 60                              | 18                           | 1,5 µm                               |
| 697.902A                               | 500 x 315 x 70                              | 34                           | 3,0 µm                               |
| 697.903A                               | 630 x 400 x 80                              | 60                           | 3,3 µm                               |
| 697.904A                               | 800 x 500 x 100                             | 120                          | 3,6 µm                               |
| 697.905A                               | 1000 x 630 x 140                            | 265                          | 4,0 µm                               |
| 697.906A                               | 1200 x 800 x 160                            | 465                          | 4,4 µm                               |
| 697.907A                               | 1600 x 1000 x 180                           | 870                          | 5,2 µm                               |

## Supporti per piani in granito

*Untergestelle für Hartgesteinplatten*

*Supports for granite plates*

- Costruzione in tubolare di ferro
- Preverniciati color azzurro officina
- Piedi regolabili con bulloni
- Regolazione con bulloni a testa tonda

- Hergestellt aus Stahl-Vierkanrohr
- Vorlackiert in Werstatt-Hellblau
- Füße mit Schrauben regulierbar
- Regulierung mit Rundkopf-Schrauben

- Made from square steel tubes
- Prevarnished in workshop light blue
- Feet adjustable with screws
- Regulation with round head screws



698.903



698.880-1-2

| Codice N°<br>Bestell Nr.<br>Order Code | Tavoli mm<br>Untergestelle mm<br>Supports mm | Per piani mm<br>Für Platten mm<br>For plates mm |
|--|--|---|
| 698.903                                | 530 x 350                                    | 630 x 400                                       |
| 698.904                                | 700 x 400                                    | 800 x 500                                       |
| 698.905                                | 900 x 530                                    | 1000 x 630                                      |
| 698.906                                | 1100 x 700                                   | 1200 x 800                                      |
| 698.907                                | 1400 x 800                                   | 1600 x 1000                                     |
| 698.909                                | 1500 x 900                                   | 1600 x 1000                                     |



698.901

698.901 Set 4 piedini antivibranti

698.880 Colonna PPA/cemento 380:480

698.881 Colonna PPA/cemento 480:580

698.882 Colonna PPA/cemento 680:780





Squadre in granito tipo collaudo grado 00

Kontroll Präzisionswinkel aus Granit Güte 00  
Control granite square grade 00

- Graniti lavorati in Italia
- Facce rettificate e lappate
- Misure grosse con fori di alleggerimento
- Forniti con certificato di collaudo

- Granit in Italien bearbeitet
- Messflächen geschliffen und geläpft
- Grosse Dim. mit Erleichterungslöchern
- Lieferung mit Prüf-Zertifikat

- Granite worked in Italy
- Surfaces ground and lapped
- Big sizes with weight saving holes
- Delivered with test certificate

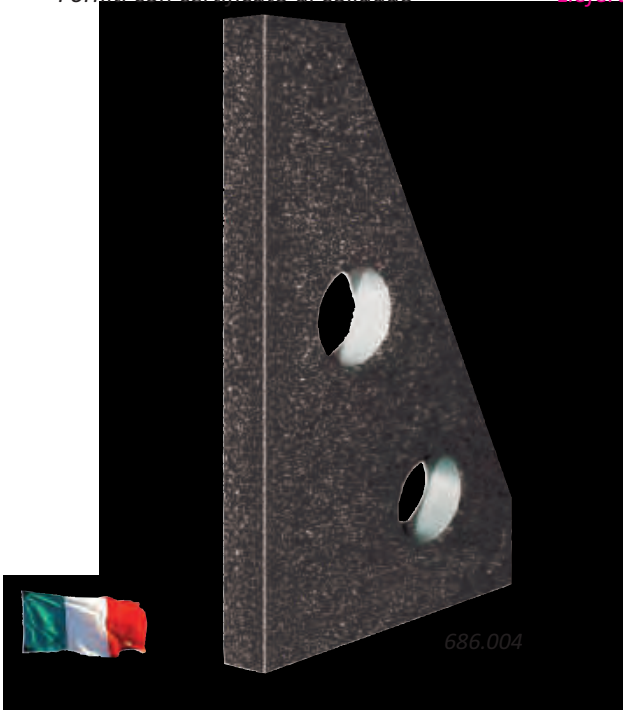

| Codice N°<br>Bestell Nr.<br>Order Code | Dimensioni mm<br>Größen mm<br>Dimensions mm | Peso Kg<br>Gewicht<br>Weight | Planarità<br>Ebenheit<br>Flatness | Perpend.<br>Winklig.<br>Perpend. |
|--|---|------------------------------|-----------------------------------|----------------------------------|
| 686.001                                | 200 x 150 x 30                              | 2                            | 2,4 µm                            | 2 µm                             |
| 686.002                                | 300 x 200 x 40                              | 5                            | 2,6 µm                            | 2 µm                             |
| 686.003                                | 400 x 250 x 50                              | 10                           | 2,8 µm                            | 2 µm                             |
| 686.004                                | 500 x 315 x 60                              | 17                           | 3,0 µm                            | 3 µm                             |
| 686.005                                | 630 x 400 x 60                              | 28                           | 3,2 µm                            | 3 µm                             |
| 686.006                                | 800 x 500 x 80                              | 63                           | 3,6 µm                            | 4 µm                             |
| 686.007                                | 1000 x 630 x 100                            | 117                          | 4,0 µm                            | 4 µm                             |
| 686.008                                | 1200 x 800 x 140                            | 210                          | 4,4 µm                            | 5 µm                             |
| 686.009                                | 1500 x 1000 x 160                           | 480                          | 6,0 µm                            | 6 µm                             |

Righe pianparallele ad "I" in granito

Parallele Granitlineale "I" Form  
Parallel granite rules "I" shape

- Graniti lavorati in Italia
- 2 facce rettificate e lappate
- Parte centrale sottigliata
- Forniti con certificato di collaudo

- Granit in Italien bearbeitet
- 2 Messflächen geschliffen und geläpft
- Zentraler Teil gewichtserleichtert
- Lieferung mit Prüf-Zertifikat

- Granite worked in Italy
- 2 surfaces ground and lapped
- Central part lowered
- Delivered with test certificate



| Codice N°<br>Bestell Nr.<br>Order Code | Dimensioni mm<br>Größen mm<br>Dimensions mm | Peso Kg<br>Gewicht<br>Weight | Parallelismo<br>Parallelität<br>Parallelisme |
|--|---|------------------------------|--|
| <b>Grado 00 - Klasse 00 - Grade 00</b> |   |                              |  |
| 682.001                                | 500 x 50 x 80                               | 5                            | 3 µm   |
| 682.002                                | 750 x 50 x 100                              | 10                           | 4 µm   |
| 682.003                                | 1000 x 60 x 140                             | 23                           | 4 µm   |
| 682.004                                | 1500 x 80 x 180                             | 40                           | 5 µm   |
| 682.005                                | 2000 x 100 x 200                            | 80                           | 6 µm   |
| <b>Grado 0 - Klasse 0 - Grade 0</b>    |   |                              |  |
| 682.011                                | 500 x 50 x 80                               | 5                            | 4 µm   |
| 682.012                                | 750 x 50 x 100                              | 10                           | 5 µm   |
| 682.013                                | 1000 x 60 x 140                             | 23                           | 6 µm   |
| 682.014                                | 1500 x 80 x 180                             | 40                           | 8 µm   |
| 682.015                                | 2000 x 100 x 200                            | 80                           | 10 µm  |

A richiesta disponibili anche in Grado 1  
con valori doppi rispetto al Grado 0  
Vedi codici 682.021 etc.



### Articoli in granito fornibili a richiesta

Artikel aus Granit lieferbar auf Anfrage  
Items in granite available on request

Piani in granito lavorati in Italia  
*Granitplatten in Italien bearbeitet*  
Granite plates worked in Italy



Dimensioni da 630x400x90 a 2500x1600x280  
(Dimensioni da 2000x1000x a 4000x2000x450)

Grado precisione 1 - 0 - 00 - 000

Piani (alleggeriti) in granito lavorati in Italia  
*(Erleichterte) Granitplatte in Italien bearbeitet*  
(Lightened) granite plates worked in Italy

Lavorazioni speciali, inserti filettati, ecc.  
*Sonderausführungen, Gewindeeinsätze, usw.*  
Special executions, threaded inserts, etc.



Inserti M3 a M16

Cave guida a "T"

Inserti fissati con resine

Fori ciechi o passanti

Fresate cieche o passanti

Prismi a "V" in granito lavorati in coppia  
*Prismen "V" aus Granit paarweise bearbeitet*  
Granite V-blocks pairwise machined



Dimensioni da 100x70x50 a 200x140x70

Grado di precisione 1 - 0 - 00

Cilindri di controllo in granito - 2 basi pianparallele  
*Kontrollzylinder aus Granit - 2 parallele Standflächen*  
Control cylinders from granite - 2 parallel bases



Dimensioni da  $\varnothing$  70x200 a  $\varnothing$  160x800

Grado di precisione da 2  $\mu$ m a 6  $\mu$ m

Cubi in granito - 2-4-6 facce parallele  
*Granitwürfel - 2-4-6 seitig parallel*  
Granite cubes - 2-4-6 faces parallel

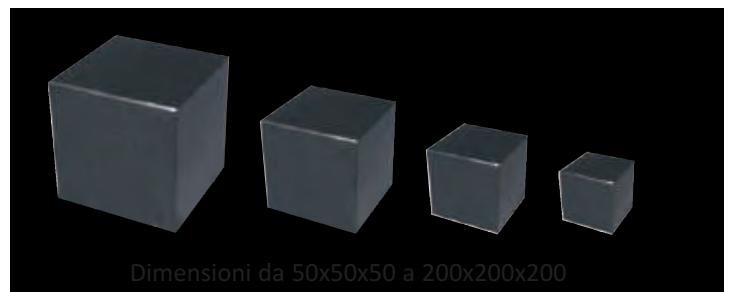

Dimensioni da 50x50x50 a 200x200x200

Grado precisione da 1,5  $\mu$ m a 2,8  $\mu$ m

Righe lineari in granito - 1 faccia rettificata e lappata  
*Granitlineal - 1 Oberfläche geschliffen und geläppt*  
Granite rules - 1 Work surface ground and lapped



Dimensioni da 300x30x50 a 2000x80x200

Grado di precisione 1 - 0 - 00





**Prodotti di marcatura e pulizia**

*Produkte zum Markieren und Reinigen  
Products for marking and cleaning*



| Codice N°<br>Bestell Nr.<br>Order Code | Descrizione articolo<br>Produktbeschreibung<br>Product description | Qtà<br>Menge<br>Qty |
|--|--|---------------------|
| <i>Prodotti specifici per granito</i>  |  |                     |
| 698.991                                | Detergente con pompetta  | 1 ltr               |
| 698.998                                | Cera polimero di lucidatura bottiglia                              | 1 ltr               |
| 698.998B                               | Cera polimero di lucidatura canistro                               | 5 ltr               |

| <i>Blu di Prussia per marcature</i> |   |        |
|-------------------------------------|---|--------|
| 698.993                             | Pasta Blu di Prussia barattolo          | 250 ml |
| 698.994                             | Bomboletta spray "Blu di Prussia" blu   | 300 ml |
| 698.995                             | Bomboletta spray "Blu di Prussia" rosso | 300 ml |

| <i>Prodotti di pulizia per granito e Blu di Prussia</i> |                                   |        |
|---|-----------------------------------|--------|
| 698.999   | Detergente universale bottiglia   | 1 ltr  |
| 698.999B  | Detergente universale canistro    | 5 ltr  |
| 698.997   | Spray eliminazione Blu di Prussia | 300 ml |

**Punte a tracciare per frese e trapani**

*Anreissnadeln für Fräs- und Bohrmaschinen  
Scribers for drilling and milling machines*

- Corpo in acciaio utensili
- Körper aus Werkzeugstahl
- Body from tool steel
- Completamente rettificato
- Vollkommen geschliffen
- Totally ground
- Forza d'incisione regolabile con la molla
- Markierungsstärke mit Feder einstellbar
- Scriber force adjustable with spring
- Punta a tracciare acciaio temprato
- Anreisspitze gehärteter Stahl
- Scriber tempered steel



| Codice N°<br>Bestell Nr.<br>Order Code | Diametro<br>Durchmesser<br>Diameter | Lungh. corpo<br>Länge Körper<br>Length body | Punta<br>Spitze<br>Scriber |
|--|-------------------------------------|---|----------------------------|
| 339.101                                | Ø 12                                | 80 (+20)                                    | Ø 5 - L 20                 |
| 339.102                                | Ø 16                                | 80 (+20)                                    | Ø 5 - L 20                 |
| 339.110                                | Punta di ricambio Ø 5 - L 20        |   |                            |
| 339.111                                | Molla di ricambio                   |   |                            |



## Calibri a tracciare con rullo

Anreiss-Messschieber mit Rolle  
Marking vernier calipers with roller

- Acciaio inox
- Asta e nonio cromato
- Punta in metallo duro intercambiabile
- Nonio  $1/20^\circ - 0,05 + 1/128''$
- Rostfreier Stahl
- Nonius und Skala verchromt
- Anreisspitze aus Hartmetall
- Ablesung  $1/20 - 0,05 + 1/128''$
- Stainless steel
- Vernier and scale chromed
- Interchangeable carbide point
- Reading  $0,05\text{mm} + 1/128''$

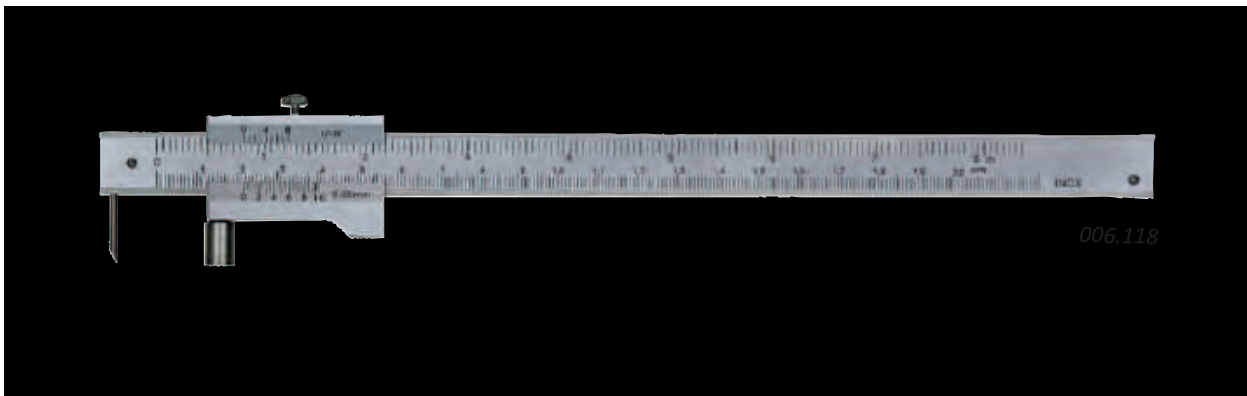

| Codice N°<br>Bestell Nr.<br>Order Code | Utile mm<br>Messbereich<br>Range mm | Nonio<br>Nonius<br>Reading |
|--|-------------------------------------|----------------------------|
| 006.118                                | 200                                 | $0,05 + 1/128''$           |
| 006.119                                | 400                                 | $0,05 + 1/128''$           |
| 006.118P                               | Punta di ricambio in metallo duro   |                            |

## Tracciatore ad asta tonda e riscontro quadro (tondo)

Streichmass mit runder Stange und quadratischer (runder) Platte  
Steel marking gauge with round rod and square (round) plate

- Piastra rettificata vedi tabella
- Asta tonda in acciaio lucido
- Punta tonda in acciaio temprato
- Nonio  $1/10^\circ - 400/500\text{mm}$  a richiesta
- Anreissplatte siehe Tabelle
- Runde Messstange aus blankem Stahl
- Runde Spitze aus gehärtetem Stahl
- Ablesung  $1/10 - 400/500$  auf Anfrage
- Ground plate see table
- Round rod from polished steel
- Round steel point hardened
- Reading  $0,1\text{mm} - 400/500$  request

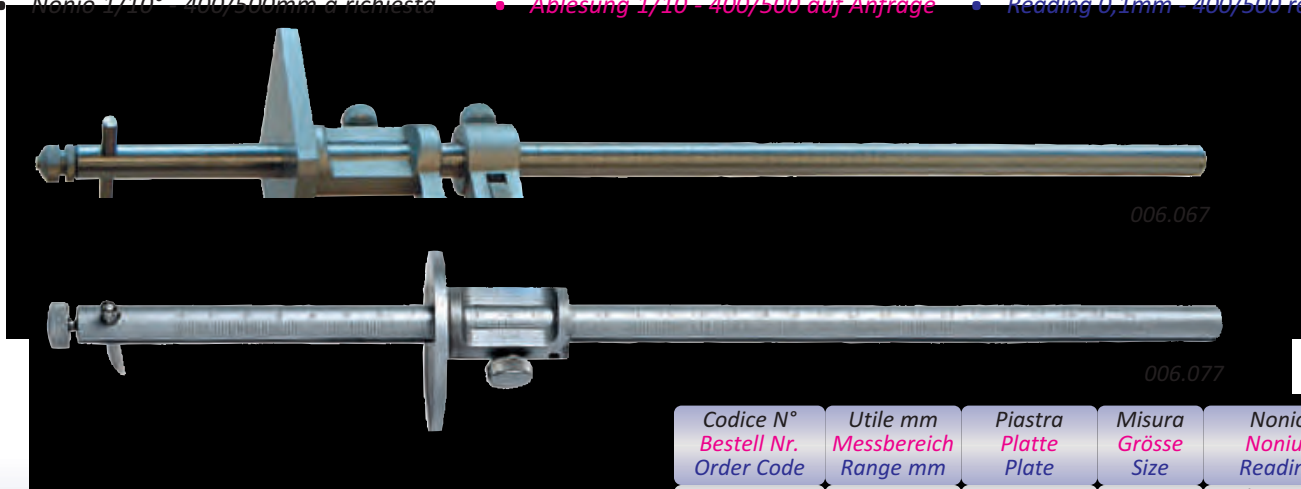

| Codice N°<br>Bestell Nr.<br>Order Code | Utile mm<br>Messbereich<br>Range mm                   | Piastra<br>Platte<br>Plate | Misura<br>Größe<br>Size | Nonio<br>Nonius<br>Reading |
|--|---|----------------------------|-------------------------|----------------------------|
| 006.067                                | 200   | quadrata                   | 60x60                   | $1/10^\circ - 0,1$         |
| 006.068                                | 300   | quadrata                   | 60x60                   | $1/10^\circ - 0,1$         |
| 006.077                                | 200   | tonda                      | $\varnothing 60$        | $1/10^\circ - 0,1$         |
| 006.078                                | 300   | tonda                      | $\varnothing 60$        | $1/10^\circ - 0,1$         |
| 006.065                                | Punta di ricambio temprata $\varnothing 5 \times L60$ |                            |                         |                            |



Compassi con cerniera rivettata

Spitzzirkel mit Nietscharnier  
Dividers with rivet hinge

- Acciaio forgiato
- Aste in sezione quadra lucidati
- Con o senza guida
- Punte temprate

- Geschmiedeter Stahl
- Kantige Schenkel poliert
- Mit oder ohne Bogen
- Spitzen gehärtet

- Forged steel
- Shafts in square section polished
- With or without guides
- Hardened points



| Codice N°<br>Bestell Nr.<br>Order Code | Lunghezza mm<br>Länge mm<br>Length mm | Codice N°<br>Bestell Nr.<br>Order Code |
|--|---------------------------------------|--|
| <b>Semplici</b>                        |                                       | <b>Con Guida</b>                       |
| 006.301                                | 150                                   | 006.311                                |
| 006.303                                | 200                                   | 006.313                                |
| 006.304                                | 250                                   | 006.314                                |
| 006.305                                | 300                                   | 006.315                                |
| 006.306                                | 400                                   | 006.316                                |
| 006.307                                | 500                                   | 006.317                                |
| 006.308                                | 600                                   | 006.318                                |
| 006.309                                | 800                                   | 006.319                                |
| 006.310                                | 1000                                  | 006.320                                |

Tastatori interni/esterni con cerniera rivettata

Innen- und Aussen-taster mit Nietscharnier  
Inside/outside calipers with rivet hinge

- Acciaio forgiato
- Aste in sezione piatta
- Finitura lucida
- Corrisponde alla DIN 6482

- Geschmiedeter Stahl
- Flache Schenkel
- Bearbeitung fein poliert
- Korrespondenz DIN 6482

- Forged steel
- Shafts in flat section
- Polished finish
- Accordance to DIN 6482



| Codice N°<br>Bestell Nr.<br>Order Code | Lunghezza mm<br>Länge mm<br>Length mm | Codice N°<br>Bestell Nr.<br>Order Code |
|--|---------------------------------------|--|
| <b>Interni</b>                         |                                       | <b>Esterni</b>                         |
| 006.331                                | 150                                   | 006.341                                |
| 006.333                                | 200                                   | 006.343                                |
| 006.334                                | 250                                   | 006.344                                |
| 006.335                                | 300                                   | 006.345                                |
| 006.336                                | 400                                   | 006.346                                |
| 006.337                                | 500                                   | 006.347                                |
| 006.338                                | 600                                   | 006.348                                |
| 006.339                                | 800                                   | 006.349                                |
| 006.340                                | 1000                                  | 006.350                                |



## Compassi a molla di precisione

Präzisions-Federzirkel  
Precision spring dividers

- Acciaio forgiato
- Aste in sezione quadra lucidati
- Vite rapida di bloccaggio
- Punta temprate o intercambiabili
- Geschmiedeter Stahl
- Kantige Schenkel poliert
- Schnellspannmutter
- Spitzen gehärtet oder auswechselbar
- Forged steel
- Shafts in square section polished
- Quick locking nut
- Hardened or interchangeable points

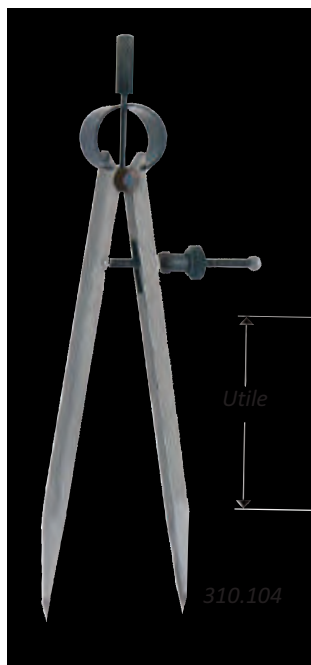

| Codice N°<br>Bestell Nr.<br>Order Code   | Lunghezza mm<br>Länge mm<br>Length mm | Codice N°<br>Bestell Nr.<br>Order Code |
|--|---------------------------------------|--|
| <b>Punte temprate</b>                    |                                       | <b>Punte intercambiabili</b>           |
| 310.100                                  | 75                                    | 310.500                                |
| 310.101                                  | 100                                   | 310.501                                |
| 310.102                                  | 125                                   | 310.502                                |
| 310.103                                  | 150                                   | 310.503                                |
| 310.104                                  | 175                                   | 310.504                                |
| 310.105                                  | 200                                   | 310.505                                |
| 310.106                                  | 250                                   | 310.506                                |
| 310.107                                  | 300                                   | 310.507                                |
| 310.108                                  | 400                                   | 310.508                                |
| 310.109                                  | 500                                   | 310.509                                |
| 310.110                                  | 600                                   | 310.510                                |
| Coppia punte di ricambio in acciaio      |                                       | 310.520                                |
| Coppia punte di ricambio in metallo duro |                                       | 310.521                                |

## Tastatori interni/esterni a molla

Federinnen- und Aussentaster  
Spring inside/outside calipers

- Acciaio forgiato
- Aste in sezione quadra lucidati
- Vite rapida di bloccaggio
- Punta temprate
- Geschmiedeter Stahl
- Kantige Schenkel poliert
- Schnellspannmutter
- Spitzen gehärtet
- Forged steel
- Shafts in square section polished
- Quick locking nut
- Hardened points



| Codice N°<br>Bestell Nr.<br>Order Code | Lunghezza mm<br>Länge mm<br>Length mm | Codice N°<br>Bestell Nr.<br>Order Code |
|--|---------------------------------------|--|
| <b>Interni</b>                         |                                       | <b>Esterni</b>                         |
| 312.100                                | 75                                    | 312.500                                |
| 312.101                                | 100                                   | 312.501                                |
| 312.102                                | 125                                   | 312.502                                |
| 312.103                                | 150                                   | 312.503                                |
| 312.104                                | 175                                   | 312.504                                |
| 312.105                                | 200                                   | 312.505                                |
| 312.106                                | 250                                   | 312.506                                |
| 312.107                                | 300                                   | 312.507                                |
| 312.108                                | 400                                   | 312.508                                |
| 312.109                                | 500                                   | 312.509                                |
| 312.110                                | 600                                   | 312.510                                |





Truschini a nonio

Höhenreisser mit Nonius  
Height gauges with vernier

- Truschini semplici con vite micrometrica
- Acciaio speciale utensili
- Scala e nonio cromato
- Punta con inserto in metallo duro
- Einfache Höhenreisser mit Feineinstellung
- Spezialer Werkzeugstahl
- Skala und Nonius verchromt
- Hartmetall Anreissnadel
- Simple height gauges with fine adjustment
- Special tool steel
- Scale and vernier chromed
- Carbide tipped scriber

| Codice N°<br>Bestell Nr.<br>Order Code | Campo di misura mm<br>Messbereich mm<br>Measuring range mm | Letture<br>Ablesung<br>Reading |
|--|--|--------------------------------|
| 006.003                                | 300  | 0,02 o 0,05                    |
| 006.003p                               | Punta di ricambio - Ersatznadel - Spare scriber            |                                |
| 006.005                                | 500  | 0,02 o 0,05                    |
| 006.005p                               | Punta di ricambio - Ersatznadel - Spare scriber            |                                |
| 006.010                                | 1000   | 0,02 o 0,05                    |
| 006.010p                               | Punta di ricambio - Ersatznadel - Spare scriber            |                                |

- Truschini con lente di ingrandimento
- Acciaio inox cromato
- Scala regolabile e vite micrometrica
- Punta con inserto in metallo duro
- Höhenreisser mit Ableselupe
- Rostfreier Stahl verchromt
- Skala regulierbar und Feineinstellung
- Hartmetall Anreissnadel
- Height gauges with magnifier lens
- Stainless steel chromed
- Adjustable scale and fine adjustment screw
- Carbide tipped scriber

| Codice N°<br>Bestell Nr.<br>Order Code | Campo di misura mm<br>Messbereich mm<br>Measuring range mm | Letture<br>Ablesung<br>Reading |
|--|--|--------------------------------|
| 006.013                                | 300  | 0,02                           |
| 006.043                                | 300 (economy)  | 0,02                           |
| 006.013p                               | Punta di ricambio - Ersatznadel - Spare scriber            |                                |
| 006.015                                | 500  | 0,02                           |
| 006.015p                               | Punta di ricambio - Ersatznadel - Spare scriber            |                                |
| 006.016                                | 600  | 0,02                           |
| 006.016p                               | Punta di ricambio - Ersatznadel - Spare scriber            |                                |
| 006.020                                | 1000   | 0,02                           |
| 006.020p                               | Punta di ricambio - Ersatznadel - Spare scriber            |                                |

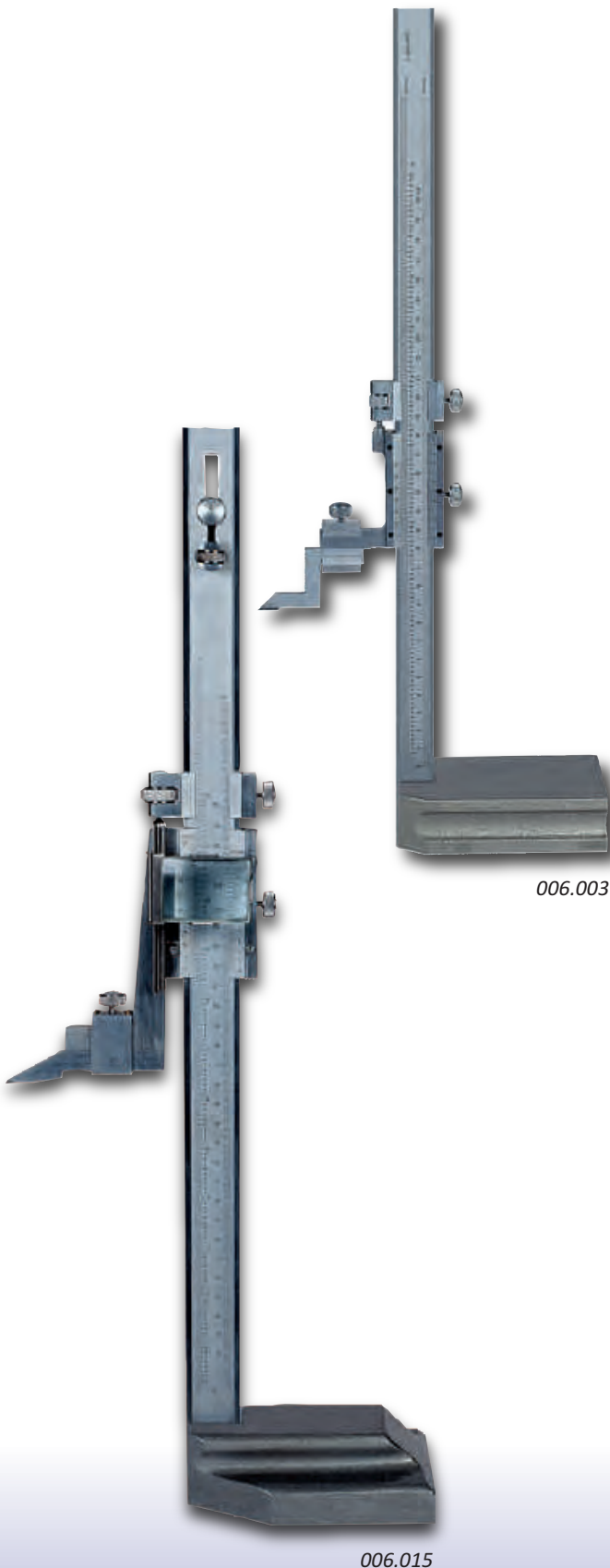

006.003

006.015



# Truschini con doppia colonna

Höhenreisser mit Doppelsäulen  
Height gauges with double column



1,5V

Truschini con doppia colonna temprata  
Rotella posteriore di avvicinamento rapido  
Comparatore 0,01 e doppio contatore mm  
Punta con inserto in metallo duro

- Höhenreisser mit gehärteten Doppelsäulen
- Hinteres Handdrehrad für Schnellverstellung
- Messuhr 0,01 und Doppelzählwerk mm
- Hartmetall Anreissnadel
- Height gauges with double tempered columns
- Back hand wheel for quick movement
- Dial gauge 0,01 and double counter mm
- Carbide tipped scriber

| Codice N°<br>Bestell Nr.<br>Order Code | Campo di misura mm<br>Messbereich mm<br>Measuring range mm | Letture<br>Ablesung<br>Reading |
|--|--|--------------------------------|
| 006.023                                | 300  | 0,01                           |
| 006.023p                               | Punta di ricambio - Ersatznadel - Spare scriber            |                                |
| 006.025                                | 500  | 0,01                           |
| 006.025p                               | Punta di ricambio - Ersatznadel - Spare scriber            |                                |
| 006.026                                | 600  | 0,01                           |
| 006.026p                               | Punta di ricambio - Ersatznadel - Spare scriber            |                                |

Truschini con doppia colonna temprata  
Rotella posteriore di avvicinamento rapido  
On/off - mm/inch - zero - preset +/-  
Punta con inserto in metallo duro

- Höhenreisser mit gehärteten Doppelsäulen
- Hinteres Handdrehrad für Schnellverstellung
- On/off - mm/inch - zero - preset +/-
- Hartmetall Anreissnadel
- Height gauges with double tempered columns
- Back hand wheel for quick movement
- On/off - mm/inch - zero - preset +/-
- Carbide tipped scriber

| Codice N°<br>Bestell Nr.<br>Order Code | Campo di misura mm<br>Messbereich mm<br>Measuring range mm | Letture<br>Ablesung<br>Reading |
|--|--|--------------------------------|
| 009.023                                | 300  | 0,01 - 0.0005"                 |
| 009.023p                               | Punta di ricambio - Ersatznadel - Spare scriber            |                                |
| 009.025                                | 500  | 0,01 - 0.0005"                 |
| 009.025p                               | Punta di ricambio - Ersatznadel - Spare scriber            |                                |
| 009.026                                | 600  | 0,01 - 0.0005"                 |
| 009.026p                               | Punta di ricambio - Ersatznadel - Spare scriber            |                                |



Truschini digitali

*Digitale Höhenreisser*  
 Digital height gauges



Truschini digitali con vite micrometrica  
 Acciaio inox cromato  
 On/off - zero - mm/inch - ABS - hold - preset +/-  
 Punta con inserto in metallo duro

*Digitale Höhenreisser mit Feineinstellung*  
 Rostfreier Stahl verchromt  
 On/off - zero - mm/inch - ABS - hold - preset +/-  
 Hartmetall Anreissnadel

Digital height gauges with fine adjustment  
 Stainless steel chromed  
 On/off - zero - mm/inch - ABS - hold - preset +/-  
 Carbide tipped scriber

| Codice N°<br>Bestell Nr.<br>Order Code | Campo di misura mm<br>Messbereich mm<br>Measuring range mm | Letture<br>Ablesung<br>Reading |
|--|--|--------------------------------|
| 009.653                                | 300  | 0,01 - 0.0005"                 |
| 009.653p                               | Punta di ricambio - Ersatznadel - Spare scriber            |                                |
| 009.655                                | 500  | 0,01 - 0.0005"                 |
| 009.655p                               | Punta di ricambio - Ersatznadel - Spare scriber            |                                |
| 009.660                                | 1000   | 0,01 - 0.0005"                 |
| 009.660p                               | Punta di ricambio - Ersatznadel - Spare scriber            |                                |



- Truschini digitali con vite micrometrica
- Rotella laterale di avvicinamento rapido
- On/off - mm/inch - zero - preset +/-
- Punta con inserto in metallo duro
- *Digitale Höhenreisser mit Feineinstellung*
- *Seitliches Handdrehrad für Schnellverstellung*
- *On/off - mm/inch - zero - preset +/-*
- *Hartmetall Anreissnadel*
- Digital height gauges with fine adjustment
- Right hand wheel for quick movement
- On/off - mm/inch - zero - preset +/-
- Carbide tipped scriber

| Codice N°<br>Bestell Nr.<br>Order Code | Campo di misura mm<br>Messbereich mm<br>Measuring range mm | Letture<br>Ablesung<br>Reading |
|--|--|--------------------------------|
| 009.683                                | 300  | 0,01 - 0.0005"                 |
| 009.683p                               | Punta di ricambio - Ersatznadel - Spare scriber            |                                |
| 009.685                                | 600  | 0,01 - 0.0005"                 |
| 009.685p                               | Punta di ricambio - Ersatznadel - Spare scriber            |                                |



# Truschini digitali ABS uscita compatibile

*Digitale Höhenreisser ABS mit Datenausgang*  
*Digital height gauges ABS data output*



- Truschini digitali con rotella
- Asta acciaio inox - base in fusione verniciata
- On/off - zero - mm/inch - hold - inc - origin
- Punta con inserto in metallo duro e portacomparatore
- *Digitale Höhenreisser mit Stellrad*
- *Messstange rostfreier Stahl - Basis lackierter Guss*
- *On/off - zero - mm/inch - hold - inc - origin*
- *Hartmetall Anreissnadel und Messuhr-Aufnahme*
- Digital height gauges with driving wheel
- Measuring rod stainless steel - base cast iron varnished
- On/off - zero - mm/inch - hold - inc - origin
- Carbide tipped scriber and dial gauge holder

| Codice N°<br>Bestell Nr.<br>Order Code | Campo di misura mm<br>Messbereich mm<br>Measuring range mm | Letture<br>Ableseung<br>Reading |
|--|--|---------------------------------|
| 009.693                                | 300  | 0,01 - 0.0005"                  |
| 009.696                                | 600  | 0,01 - 0.0005"                  |
| 009.693p                               | Punta di ricambio per 009.693 e 009.696                    |                                 |
| 009.697                                | Cavo di collegamento truschini/comparatore                 |                                 |
| 009.904                                | Visualizzatore con fondello magnetico incl. cavo           |                                 |

| Codice N°<br>Bestell Nr.<br>Order Code | Utile mm<br>Messbereich<br>Range mm | Letture<br>Ableseung<br>Reading | Quadrante<br>Zifferblatt<br>Bezel | Precisione<br>Genauigkeit<br>Precision |
|--|-------------------------------------|---------------------------------|-----------------------------------|--|
| <b>0,01 - centesimale</b>              |                                     |                                 |                                   |  |
| 004.935                                | 0 : 12,7                            | 0,01                            | ∅ 57                              | ±0,02                                  |
| 004.936                                | 0 : 25                              | 0,01                            | ∅ 57                              | ±0,02,5                                |



Truschini digitali dotati di uscita dati RB6 (compatibile con altri sistemi) collegabile al visualizzatore esterno 009.904

Inoltre possiede un l'ingresso dati RB5 per comparatori digitali 004.935-6

Il display del truschino mostra il quel caso la somma dei dati del truschino e del comparatore







Calibri a tracciare (calibri per mattonelle)

*Streichmasse*  
*Flat marking gauges*

- Acciaio inox
- Rostfreier Stahl
- Stainless steel
- Asta cromata
- Messstange / Skala verchromt
- Measuring rod / scale chromed
- Piastrina di tracciatura temprata
- Anreisskante gehärtet
- Marking plate hardened
- Nonio 1/10° - 0,1
- Ablesung 1/10 - 0,1
- Reading 0,1mm



| Codice N°<br>Bestell Nr.<br>Order Code | Utile mm<br>Messbereich<br>Range mm | Nonio<br>Nonius<br>Reading |
|--|-------------------------------------|----------------------------|
| 006.101                                | 200                                 | 1/10° - 0,1                |
| 006.102                                | 250                                 | 1/10° - 0,1                |
| 006.103                                | 300                                 | 1/10° - 0,1                |

Punte a tracciare con punte MD intercambiabili

*Reissnadeln mit auswechselbaren HM Spitzen*  
*Scribers with interchangeable carbide points*

- 006.204L - Nichellata - punta fissa MD 20
- 006.204L - Vernickelt - feste Spitze HM 20
- 006.204L - Nickel plated - fix point 20
- 006.204C - Nichellata - punta fissa MD 5
- 006.204C - Vernickelt - feste Spitze HM 5
- 006.204C - Nickel plated - fix point 5
- 006.205N - Zigrinata - punta interc. MD
- 006.205N - Gerändelt - ausw. Spitze HM
- 006.205N - Knurled - interch. point HM
- 006.207N - Gommata - punta interc. MD
- 006.207N - Gummiert - ausw. Spitze
- 006.207N - Rubber handle - Carbide pt.

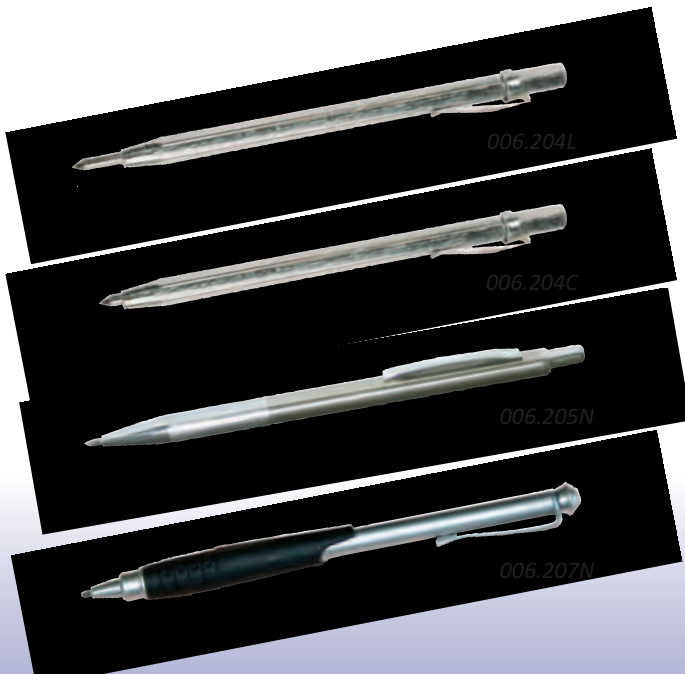

| Codice N°<br>Bestell Nr.<br>Order Code | Lunghezza<br>Länge mm<br>Length mm | Descrizione<br>Beschreibung<br>Description |
|--|------------------------------------|--|
| 006.204L                               | 160                                | Punta fissa in MD L 20mm                   |
| 006.204C                               | 145                                | Punta fissa in MD L 5mm                    |
| 006.205N                               | 150                                | Penna metallica zigrinata                  |
| 006.205P                               |                                    | Punta di ricambio                          |
| 006.207N                               | 140                                | Penna con impugnatura antiscivolo          |
| 006.207P                               |                                    | Punta di ricambio                          |