

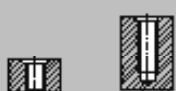
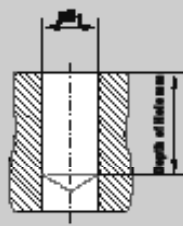
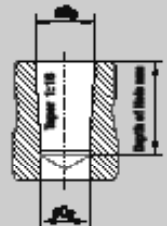

DESCRIZIONE: **Maschi a mano**

CODICE: **F 7819 1014**

Version	Straight Flute, Form C, 2 - 3 Threads Chamfer						Core Hole Diameter for American Taper Pipe Thread NPT, Taper 1 : 16 acc. to ANSI B 1.20.1				
Type of Hole											
Surface Treatment	Steam Tempered										
Catalogue-No.	2700/78										
Tolerance											
							<p>rough-drill cylindrically</p>  <p>rough-drill cylindrically and grind conically with reamer</p> 				
Application	Unalloyed Steels; Tensile Strength $\leq 800 \text{ N/mm}^2$										
add. see Page 16, 17											
Coolant	Cutting Oil or Emulsion										
Cutting Speed v_c	5 - 10 m/min										
							rough-drill cylindrically		rough-drill cylindrically and grind conically with reamer		
d₁	P (Gg1*)	l₁	l₂	d₂	□	X-Dim*	Ø D₁	Depth of Hole	Ø D₁	Ø D₂	Depth of Hole
							mm	mm	mm	mm	mm
1/16	27	56	12	6	4,9	9,7	6,25	12,00	6,00	6,39	12,00
1/8	27	63	12	7	5,5	9,7	8,50	12,00	8,25	8,74	12,00
1/4	18	63	20	11	9	14,2	11,10	17,50	10,70	11,36	17,50
3/8	18	70	22	12	9	14,5	14,70	17,60	14,10	14,80	17,60
1/2	14	80	22	16	12	19,0	18,00	22,90	17,40	18,32	22,90
3/4	14	100	22	20	16	19,5	23,25	23,00	22,60	23,67	23,00
1	11 1/2	110	32	25	20	23,4	29,25	27,40	28,50	29,69	27,40
1 1/4	11 1/2	125	32	32	24	23,9	38,00	28,10	37,00	38,45	28,10
1 1/2	11 1/2	140	36	36	29	23,9	44,25	28,40	43,50	44,52	28,40
2	11 1/2	160	36	45	35	24,3	56,25	28,40	55,00	56,56	28,40
* The recommended X-dimensions are for reference purpose only.											